

SUTAI 速泰
Formwork & Scaffolding



速泰

SUTAI SCAFFOLD

HENAN SUTAI CONSTRUCTION EQUIPMENT CO., LTD

Contents

Company Profile	1
Ringlock System Scaffold	2
Ringlock Scaffold Accessories	11
Cuplock System Scaffold	12
Cuplock Scaffold Accessories	16
Kwikstage System Scaffold	17
Haki System Scaffold	20
Frame System Scaffold	24
Frame Scaffold Accessories	27
Steel Prop	28
Steel Prop Accessories	29
Packing Rack	29
Steel Grating	30
Aluminum Formwork	31
Aluminum Formwork Accessories	32
Aluminum Products	33
Scaffolding Couplers	36
Quality Control	37
Packing & Delivery	38

Company Profile

Henan Sutai Construction Equipment Co., Ltd. is located in Zhengzhou, the central plain of China with convenient transportation. The company has production plants in Jiangsu Province, Hebei Province and Tianjin. Our team has more than ten years of project design, construction and production



experience in scaffold and formwork business. In order to better serve the scaffold and formwork industry and provide customers with better services and products, we established Henan Sutai Construction Equipment Co., Ltd. in 2020. We can provide steel and aluminum products, including ringlock scaffold system, cuplock scaffold system, kwikstage scaffold system, frame scaffold system, formwork system and other customized products. Our business purpose is to control product quality and save costs for customers.

Ringlock System Scaffold

Ringlock Ledger

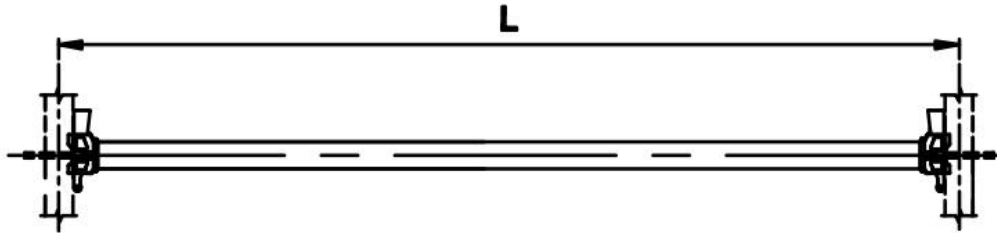

Item No.	Description	L(Meters)	L(Inches)
STRL 730	0.73M Ledger	0.73	28.74
STRL 1090	1.09M Ledger	1.09	42.91
STRL 1570	1.57M Ledger	1.57	61.81
STRL 2070	2.07M Ledger	2.07	81.50
STRL 2570	2.57M Ledger	2.57	101.18
STRL 3070	3.07M Ledger	3.07	120.87

Ringlock Standard

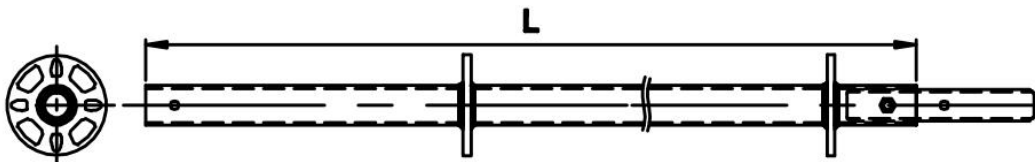

Item No.	Description	L(Meters)	L(Inches)
STRS 500	1 Ring Standard	0.5	19.69
STRS 1000	2 Ring Standard	1.0	39.37
STRS 1500	3 Ring Standard	1.5	59.06
STRS 2000	4 Ring Standard	2.0	78.74
STRS 2500	5 Ring Standard	2.5	98.43
STRS 3000	6 Ring Standard	3.0	118.11
STRS 3500	7 Ring Standard	3.5	137.80
STRS 4000	8 Ring Standard	4.0	157.48

Material, dimensions and surface treatment can be customized on request.

Ringlock System Scaffold

Ringlock Diagonal Brace

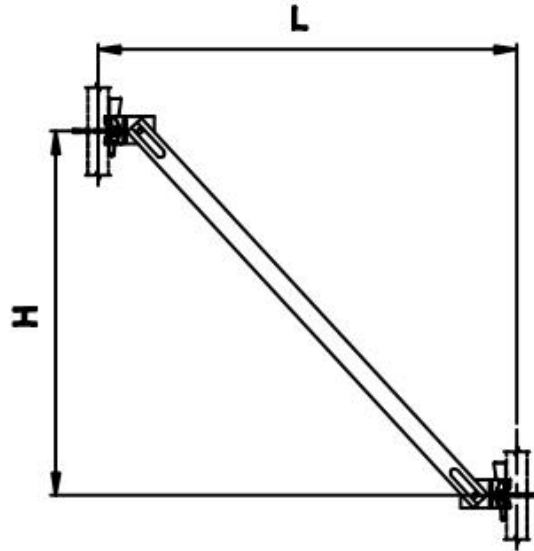

Item No.	Description	L(Meters)	H(Meters)	L(Inches)	H(Inches)
STDB 7320	0.73*2.0 Diagonal Brace	0.73	2.0	28.74	78.74
STDB 1520	1.57*2.0 Diagonal Brace	1.57	2.0	61.81	78.74
STDB 2020	2.0*2.0 Diagonal Brace	2.0	2.0	78.74	78.74
STDB 2520	2.57*2.0 Diagonal Brace	2.57	2.0	101.18	78.74
STDB 3020	3.048*2.0 Diagonal Brace	3.048	2.0	120	78.74

Ringlock Base Collar

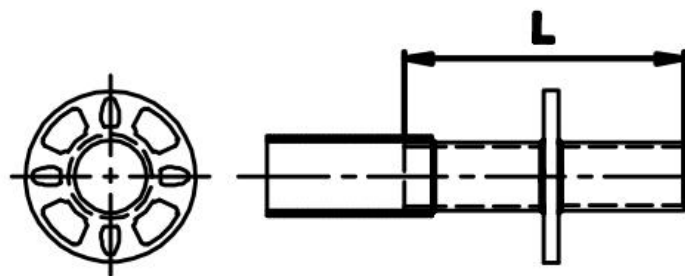

Item No.	Description	L(Meters)	L(Inches)
STBC 200	0.2M Base Collar	0.20	7.87
STBC 180	0.18M Base Collar	0.18	7.08

Material, dimensions and surface treatment can be customized on request.

Ringlock System Scaffold

Base Screw Jack

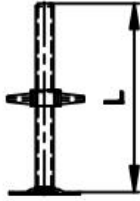

Item No.	Description	L (Meters)	L (Inches)
STRBJ 061	0.61M Base Screw Jack	0.61	24.02

Swivel Base Jack

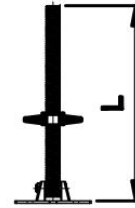

Item No.	Description	L (Meters)	L (Inches)
STSBJ 061	0.61M Swivel Base Jack	0.61	24.02

Round Ring Clamp



Casero Screw Jack

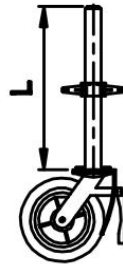

Caster Whed



Double Ends

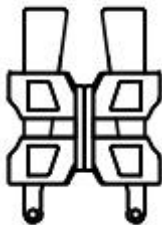

Swivel Coupler

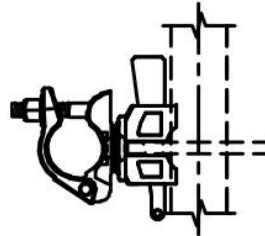

Double Coupler

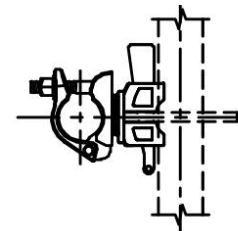

Plank-Ledger Transom Beam

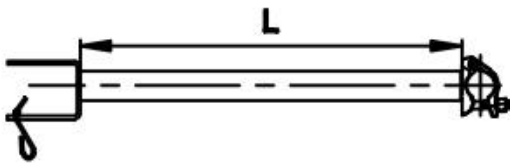

Plank-Ledger Transom Beam



Transom Beam

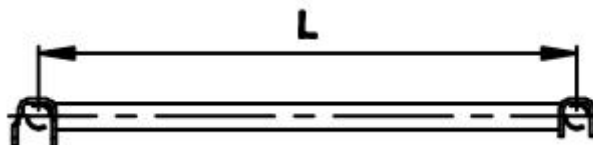

Material, dimensions and surface treatment can be customized on request.

Ringlock System Scaffold

Ringlock Steel Stair

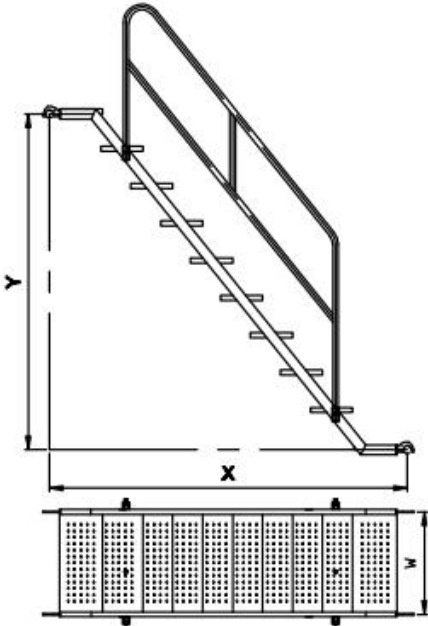

Item No.	Description	L(Meters)	H(Meters)	L(Inches)	H(Inches)
STSS 7320	0.73*2.0 Steel Stair	0.73	2.0	28.74	78.74
STSS 1520	1.57*2.0 Steel Stair	1.57	2.0	61.81	78.74
STSS 2020	2.0*2.0 Steel Stair	2.0	2.0	78.74	78.74
STSS 2520	2.57*2.0 Steel Stair	2.57	2.0	101.18	78.74
ST S3020	3.048*2.0 Steel Stair	3.048	2.0	120	78.74

Ringlock Ladder Bracket

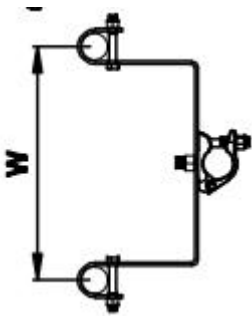

Ringlock Steel Ladder

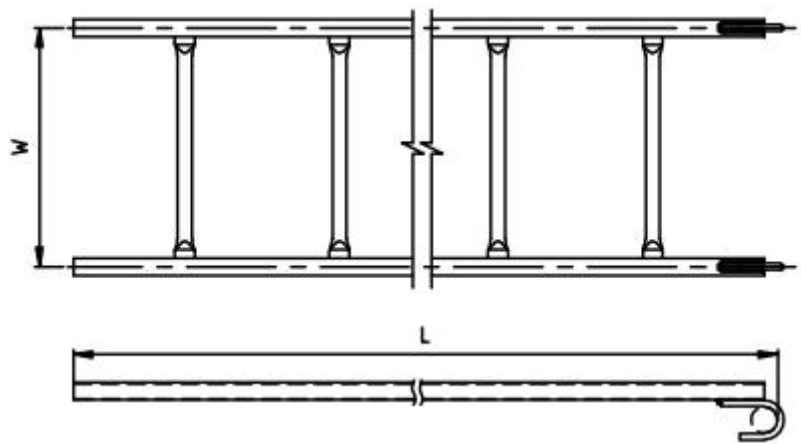

Item No.	Description	L(Meters)	L(Inches)
STRSL 914	0.914M Steel Ladder	0.914	36
STRSL 1524	1.52M Steel Ladder	1.524	60
STRSL 3048	3.048 Steel Ladder	3.048	120

Material, dimensions and surface treatment can be customized on request.

Ringlock System Scaffold

Tubular Anchorage with Hook

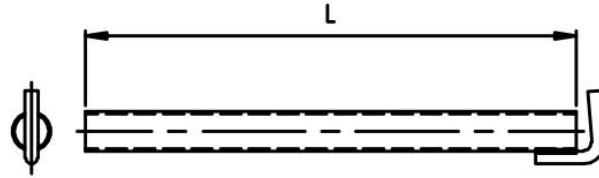

Item No.	Description	L(Meters)	L(Inches)
STTA 500	0.5M Tubular Anchorage	0.5	19.69
STTA 1000	1M Tubular Anchorage	1.0	39.37
STTA 1500	1.5M Tubular Anchorage	1.5	59.06

Coupler Spigot

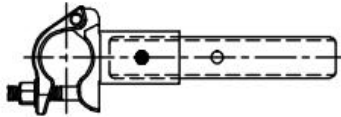

Steel Plank 228mm Width

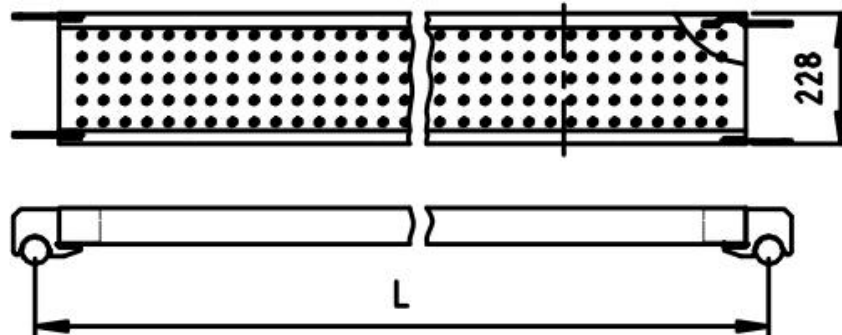

Item No.	Description	L(Meters)	L(Inches)
STSP 228-730	W228 Steel Plank	0.73	28.74
STSP 228-1090	W228 Steel Plank	1.09	42.91
STSP 228-1570	W228 Steel Plank	1.57	61.81
STSP 228-2070	W228 Steel Plank	2.07	81.50
STSP 228-2570	W228 Steel Plank	2.57	101.18
STSP 228-3070	W228 Steel Plank	3.07	120.87

Material, dimensions and surface treatment can be customized on request.

Ringlock System Scaffold

Steel Plank 320mm Width

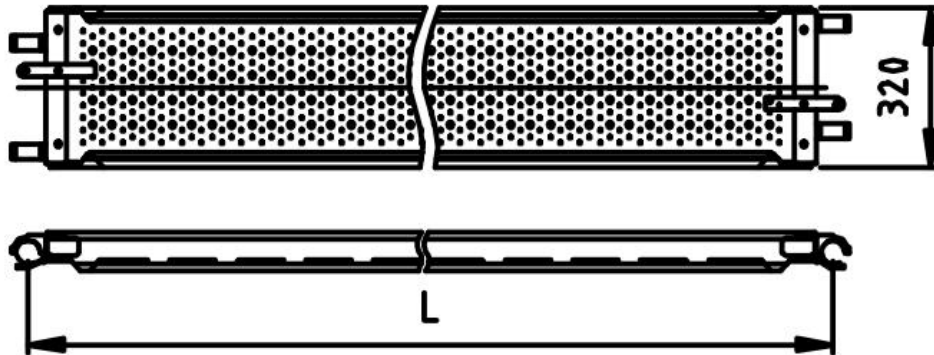

Item No.	Description	L(Meters)	L(Inches)
STSP 320-730	W320 Steel Plank	0.73	28.74
STSP 320-1090	W320 Steel Plank	1.09	42.91
STSP 320-1570	W320 Steel Plank	1.57	61.81
STSP 320-2070	W320 Steel Plank	2.07	81.50
STSP 320-2570	W320 Steel Plank	2.57	101.18
STSP 320-3070	W320 Steel Plank	3.07	120.87

Steel Plank 241mm Width

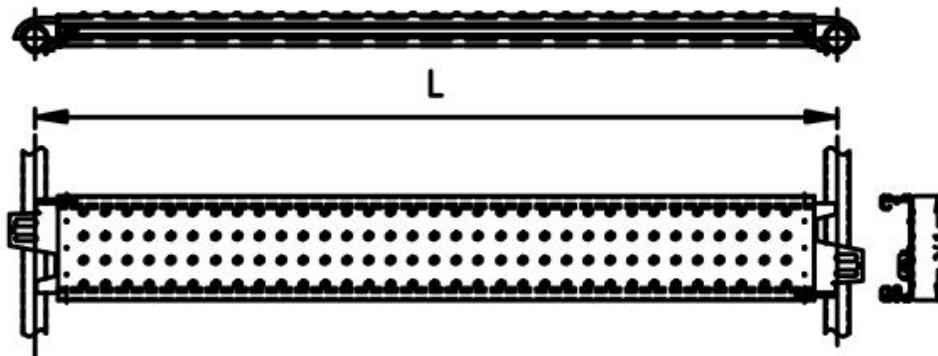

Item No.	Description	L(Meters)	L(Inches)
STSP 241-730	W241 Steel Plank	0.73	28.74
STSP 241-1090	W241 Steel Plank	1.09	42.91
STSP 241-1570	W241 Steel Plank	1.57	61.81
STSP 241-2070	W241 Steel Plank	2.07	81.50
STSP 241-2570	W241 Steel Plank	2.57	101.18
STSP 241-3070	W241 Steel Plank	3.07	120.87

Material, dimensions and surface treatment can be customized on request.

Ringlock System Scaffold

Aluminum Plywood Trapdoor Platform

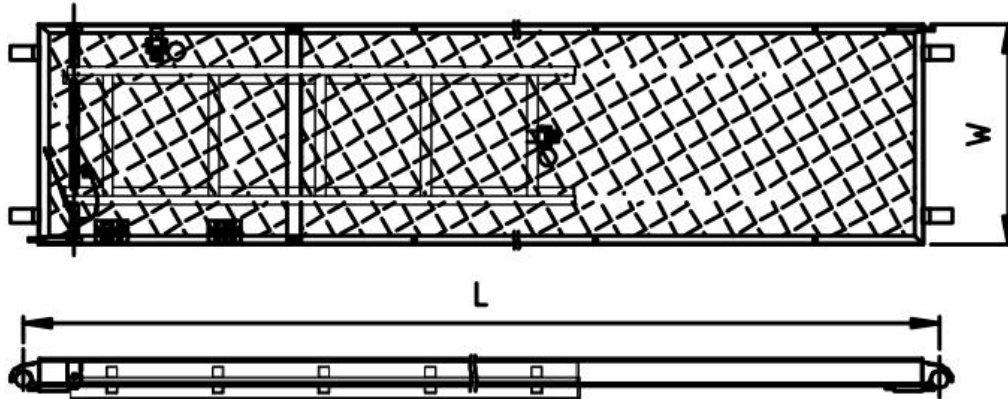

Item No.	Description	L(Meters)	L(Inches)
STSP 610-730	W610 Steel Plank	0.73	28.74
STSP 610-1090	W610 Steel Plank	1.09	42.91
STSP 610-1570	W610 Steel Plank	1.57	61.81
STSP 610-2070	W610 Steel Plank	2.07	81.50
STSP 610-2570	W610 Steel Plank	2.57	101.18
STSP 610-3070	W610 Steel Plank	3.07	120.87

Seams Cover Plate

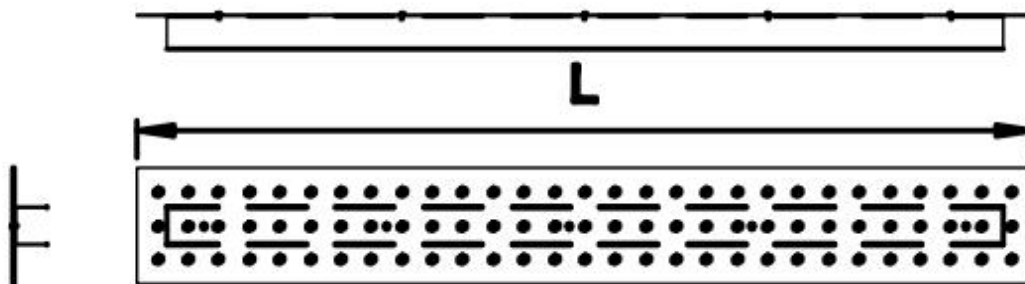

Item No.	Description	L(Meters)	L(Inches)
STCP 730	Seams Cover Plate	0.73	28.74
STCP 1090	Seams Cover Plate	1.09	42.91
STCP 1570	Seams Cover Plate	1.57	61.81
STCP 2070	Seams Cover Plate	2.07	81.50
STCP 2570	Seams Cover Plate	2.57	101.18
STCP 3070	Seams Cover Plate	3.07	120.87

Material, dimensions and surface treatment can be customized on request.

Ringlock System Scaffold

Toe Board

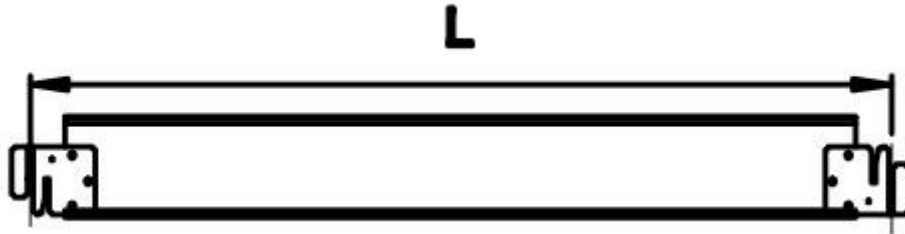

Item No.	Description	L(Meters)	L(Inches)
STTB 730	Toe Board	0.73	28.74
STTB 1090	Toe Board	1.09	42.91
STTB 1570	Toe Board	1.57	61.81
STTB 2070	Toe Board	2.07	81.50
STTB 2570	Toe Board	2.57	101.18
STTB 3070	Toe Board	3.07	120.87

Ringlock Board Bracket

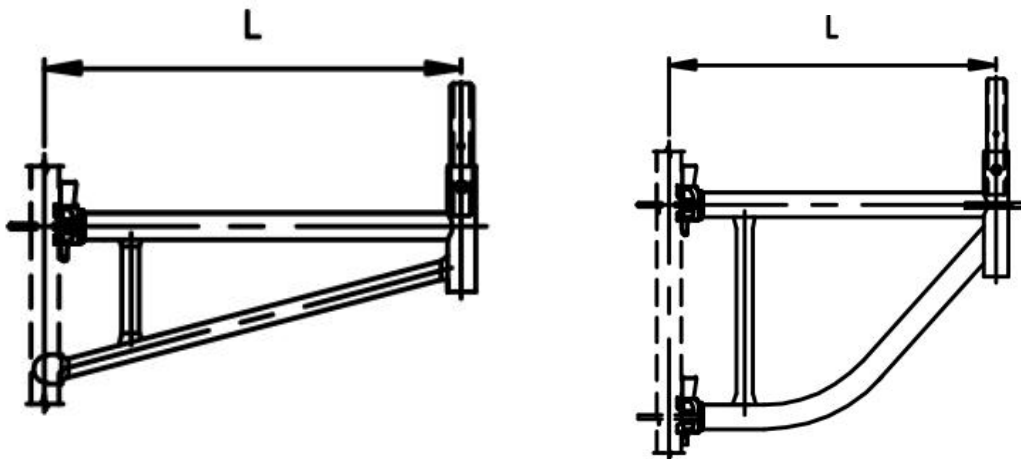

Item No.	Description	L(Meters)	L(Inches)
STBB 040	0.40M Ringlock Board Bracket	0.40	15.75
STBB 065	0.65M Ringlock Board Bracket	0.65	25.59
STBB 088	0.88M Ringlock Board Bracket	0.88	34.65

Material, dimensions and surface treatment can be customized on request.

Ringlock System Scaffold

Lattice Girder

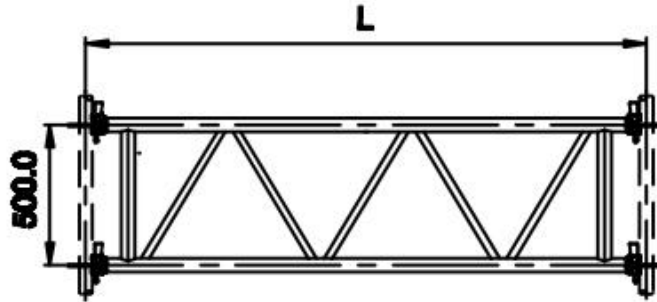

Item No.	Description	L(Meters)	L(Inches)
STLG 207	Ringlock Lattice Girder	2.07	81.49
STLG 257	Ringlock Lattice Girder	2.57	101.18

Bridge Ledger

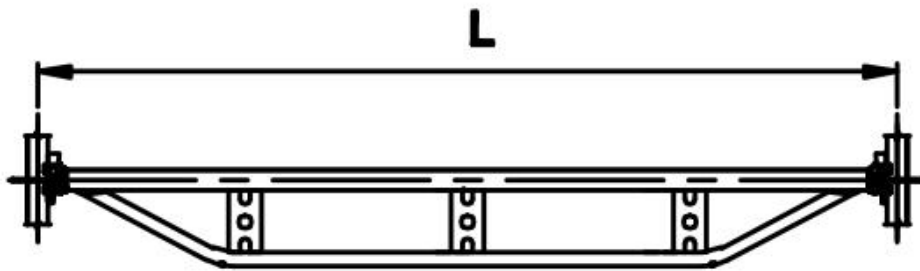

Item No.	Description	L(Meters)	L(Inches)
STRBL 207	Ringlock Bridge Ledger	2.07	81.49
STRBL 257	Ringlock Bridge Ledger	2.57	101.18

Security Door (1)

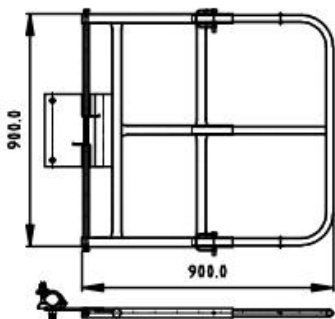

Security Door (2)

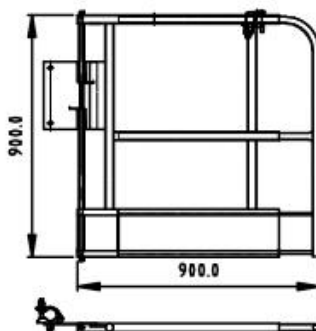

Security Door (3)

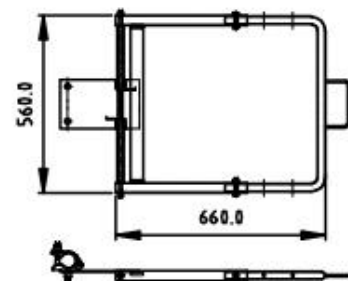

Material, dimensions and surface treatment can be customized on request.

Ringlock Scaffold Accessories



Rosette



Brace Head



Wedge Pin



Ringlock Spigot



Ledger End



Rosette Coupler



Double Ends



Jack Base Nut



Caster Wheel



Casero Screw Jack



Swivel Coupler



Double Coupler



Rosette Clamp



Spigot Coupler

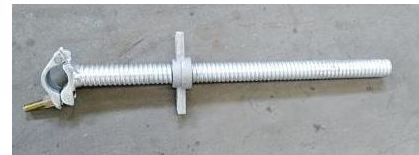

Threaded Rod with Coupler

Material, dimensions and surface treatment can be customized on request.

Cuplock System Scaffold

Cuplock Standard



Item No.	Description	L(Meters)	L(Inches)
STCS 500	0.5M Cuplock Standard	0.5	19.69
STCS 1000	1.0M Cuplock Standard	1.0	39.37
STCS 1500	1.5M Cuplock Standard	1.5	59.06
STCS 2000	2.0M Cuplock Standard	2.0	78.74
STCS 2500	2.5M Cuplock Standard	2.5	98.43
STCS 3000	3.0M Cuplock Standard	3.0	118.11

Cuplock Ledger

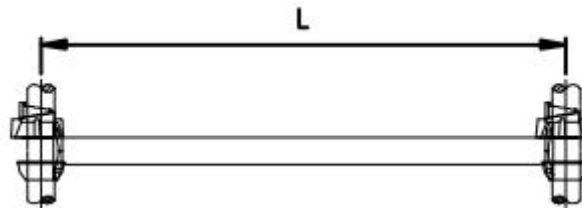

Item No.	Description	L(Meters)	L(Inches)
STCL 036	0.9144M Cuplock Ledger	0.9144	36
STCL 040	1.0668M Cuplock Ledger	1.0668	42
STCL 050	1.2192M Cuplock Ledger	1.2192	48
STCL 060	1.524M Cuplock Ledger	1.52	60
STCL 070	1.8288M Cuplock Ledger	1.8288	72
STCL 080	2.1336M Cuplock Ledger	2.1336	84
STCL 090	2.4384M Cuplock Ledger	2.4384	96
STCL 100	3.048M Cuplock Ledger	3.048	120

Material, dimensions and surface treatment can be customized on request.

Cuplock System Scaffold

Cuplock Diagonal Brace

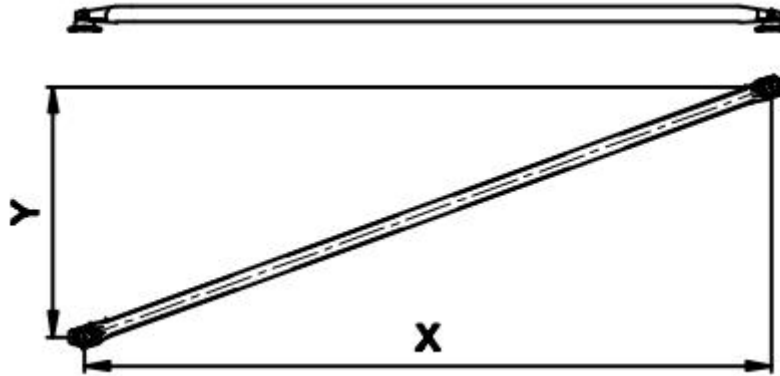

Item No.	Description	L(Meters)	H(Meters)	L(Inches)	H(Inches)
STCB 032	0.914*2M Cuplock Ledger	0.9144	2.0	36	78.74
STCB 042	1.219*2M Cuplock Ledger	1.2192	2.0	48	78.74
STDB 052	1.524*2M Cuplock Ledger	1.524	2.0	60	78.74
STDB 072	2.1336*2M Cuplock Ledger	2.1336	2.0	84	78.74
STDB 082	2.438*2M Cuplock Ledge	2.438	2.0	96	78.74
STDB 102	3.048*2M Cuplock Ledger	3.048	2.0	120	78.74

Cuplock Board Bracket



Item No.	Description	L(Meters)	L(Inches)
STCBB 040	One Board	0.3048	12
STCBB 065	Two Board	0.565	22.24
STCBB 088	Three Board	0.795	31.3

Material, dimensions and surface treatment can be customized on request.

Cuplock System Scaffold

Assembly Stair

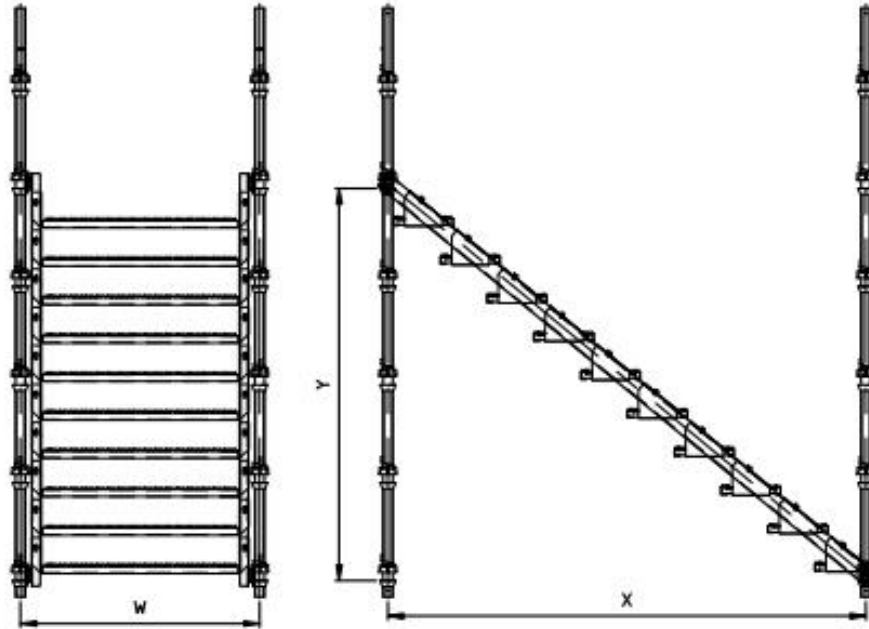

Item No.	Description	X(Meters)	Y(Meters)	X(Inches)	Y(Inches)
STAS 7320	0.73*2.0 Assembly Stair	0.73	2.0	28.74	78.74
STAS 1520	1.57*2.0 Assembly Stair	1.57	2.0	61.81	78.74
STAS 2020	2.0*2.0 Assembly Stair	2.0	2.0	78.74	78.74

Self Locking Steel Tube

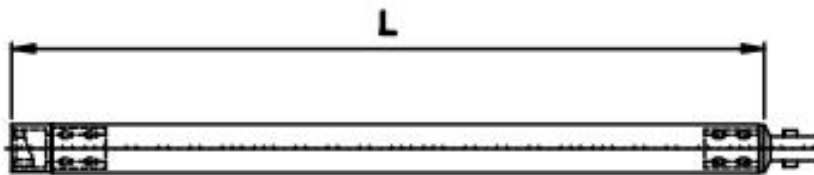

Item No.	Description	L(Meters)	L(Inches)
STSLST 040	4'	1.2192	48
STSLST 050	8'	2.4384	96
STSLST100	10'	3.048	120

Material, dimensions and surface treatment can be customized on request.

Cupock System Scaffold

Cuplock Bridge Ledger

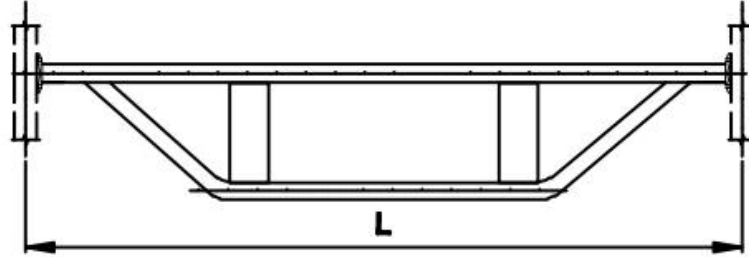

Item No.	Description	L(Meters)	L(Inches)
STCBL 207	Cuplock Bridge Ledger	2.07	81.49
STCBL 257	Cuplock Bridge Ledger	2.57	101.18

Cuplock Steel Ladder

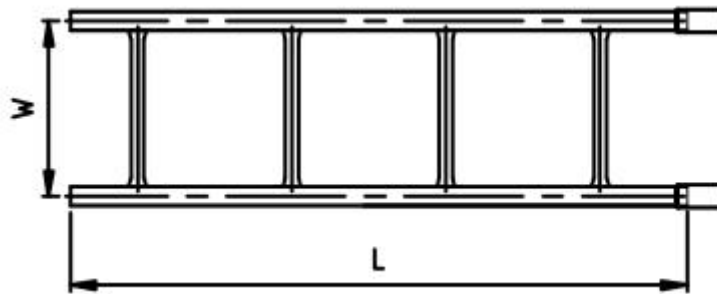

Item No.	Description	L(Meters)	L(Inches)
STCSL 914	0.914M Steel Ladder	0.914	36
STCSL 1524	1.52M Steel Ladder	1.524	60
STCSL 3048	3.048 Steel Ladder	3.048	120

Ladder Bracket

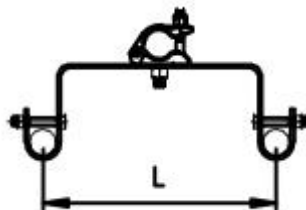

Material, dimensions and surface treatment can be customized on request.

Cuplock Scaffold Accessories



Top Cup



Bottom Cup



Ledger Blade



Beam Support Bracket

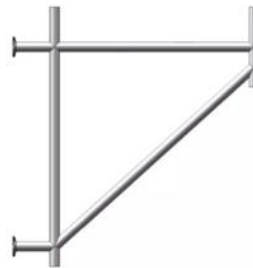

Cantilever Beam Frame

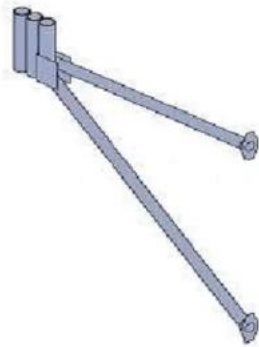

Beam Support Bracket



Board Bracket



Cuplock Scaffold Angle Transom

Material, dimensions and surface treatment can be customized on request.

Kwikstage System Scaffold

Kwikstage Ledger

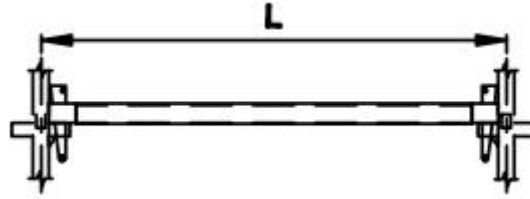

Item No.	Description	L(Meters)	L(Inches)
STCL560	560 Kwikstage Ledger	0.56	22.05
STCL 762	762 Kwikstage Ledger	0.762	30
STCL 812	812 Kwikstage Ledger	0.812	31.97
STCL 1000	1000 Kwikstage Ledger	1.0	39.37
STCL 1270	1270 Kwikstage Ledger	1.27	50
STCL 2438	2430 Kwikstage Ledger	2.438	95.98

Kwikstage Standard

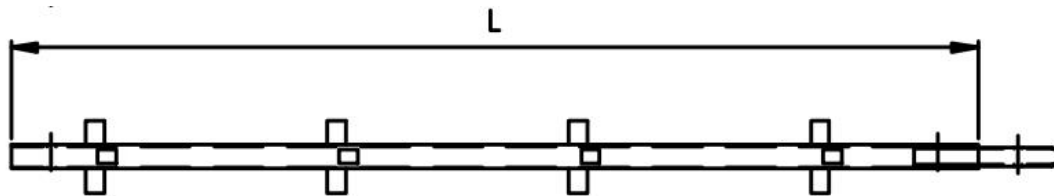

Item No.	Description	L(Meters)	L(Inches)
STKS 10	990 KwikstageStandard	0.9906	39
STKS 15	1485 Kwikstage Standard	1.4859	58.5
STKS 20	1981 Kwikstage Standard	1.9812	78
STKS 25	2478 Kwikstage Ledger	2.4765	97.5
STKS 30	2971 Kwikstage Ledger	2.9718	117

Material, dimensions and surface treatment can be customized on request.

Kwikstage System Scaffold

Kwikstage Diagonal Brace

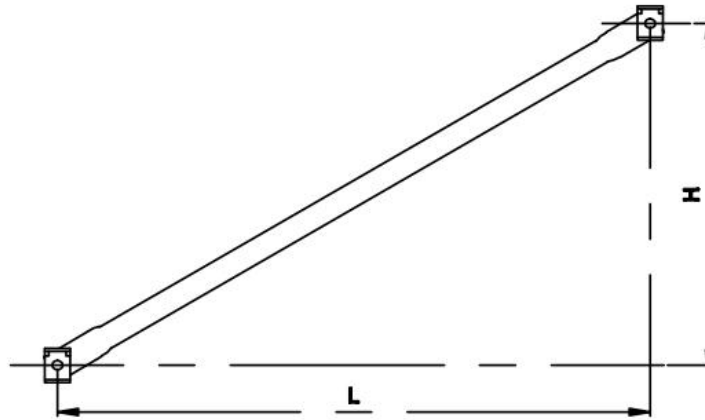

Item No.	Description	L(Meters)	H(Meters)	L(Inches)	H(Inches)
STKB 01	762*1486 Kwikstage Brace	0.762	0.406	30	58.5
STKB 02	1270*1486 Kwikstage Brace	1.27	1.485	50	58.5
STKB 03	1270*1981.2 Kwikstage Brace	1.27	1.981	50	77.99
STKB 04	1829*1981.2 Kwikstage Brace	1.829	1.981	72.01	77.99
STKB 05	2438*1981.2 Kwikstage Brace	2.438	1.981	95.98	77.99
STKB 06	2438*2476.5 Kwikstage Brace	2.438	2.476	95.98	97.48

Kwikstage Tie Bar

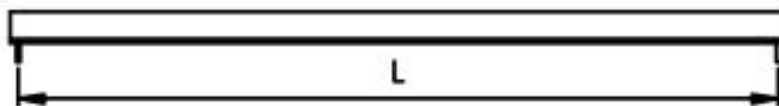

Item No.	Description	L(Meters)	L(Inches)
STKTB 762	762 Kwikstage Tie Bar	0.762	30
STKTB 1270	1270 Kwikstage Tie Bar	1.27	50
STKTB 1829	1829 Kwikstage Tie Bar	1.829	72.01
STKTB 2438	2438 Kwikstage Tie Bar	2.438	95.98

Material, dimensions and surface treatment can be customized on request.

Kwikstage System Scaffold

Kwikstage Transom

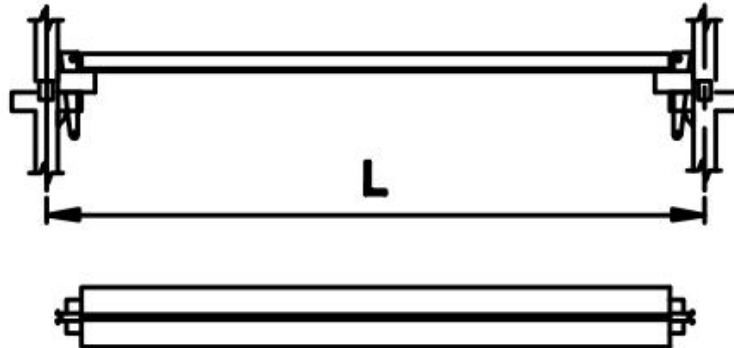

Item No.	Description	L(Meters)	L(Inches)
STKT 762	762 Kwikstage Transom	0.762	30
STKT 1270	1270 Kwikstage Transom	1.27	50
STKT 1829	1829 Kwikstage Transom	1.829	72.01
STKT 2438	2438 Kwikstage Transom	2.438	95.98

Kwikstage Board Bracket

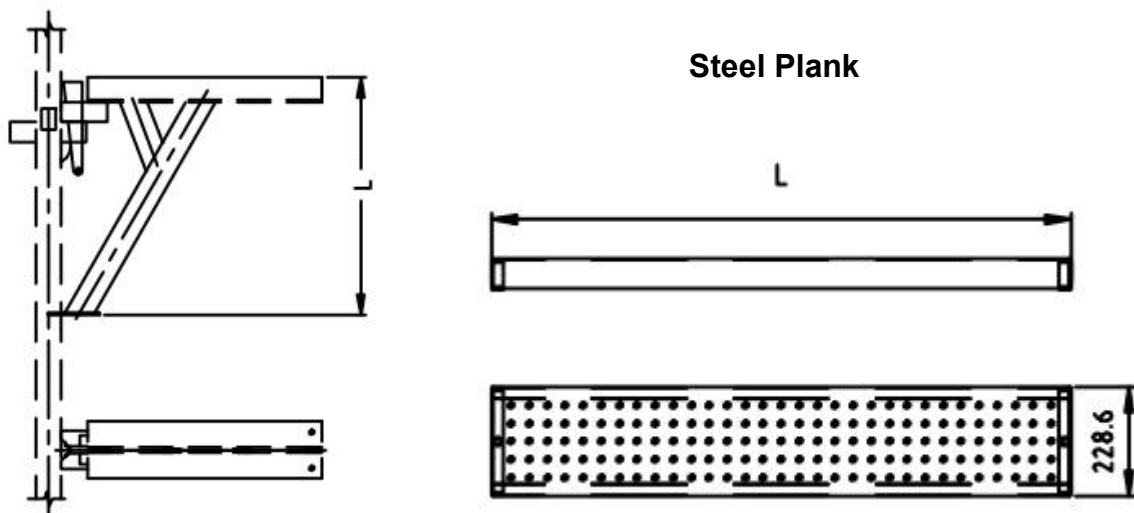

Material, dimensions and surface treatment can be customized on request.

Haki System Scaffold

Haki Single tube beam

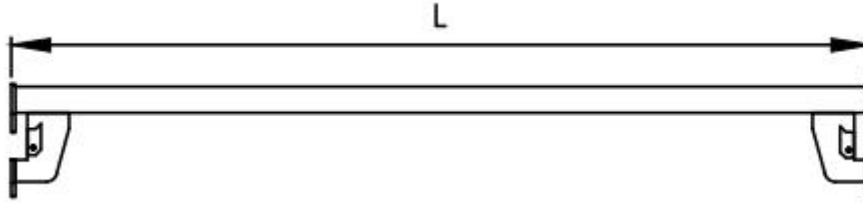

Item No.	Description	L(Meters)	L(Inches)
STHSB	1605 Haki Single tube beam	1.605	63.19

Haki Ledger beam

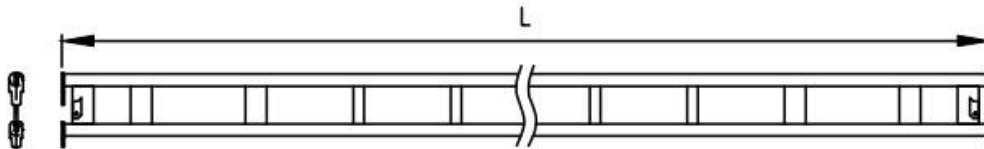

Item No.	Description	L(Meters)	L(Inches)
STHLB	1000 Haki Ledger beam	1.0	39.37
STHLB	3000 Haki Ledger beam	3.0	118.11

Haki Standard

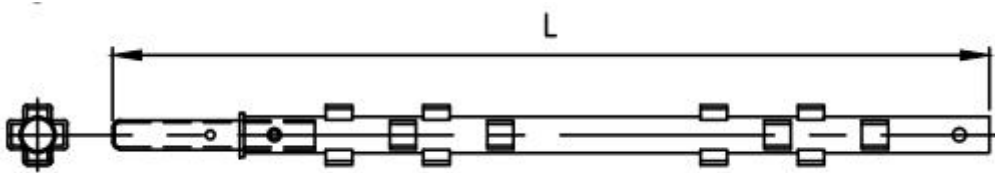

Item No.	Description	L(Meters)	L(Inches)
STHS 10	1000 Haki Standard	1.0	39.37
STHS 15	10500 Haki Standard	1.5	59.06
STHS 20	2000 Haki Standard	2.0	78.74
STHS 25	2500 Haki Standard	2.5	98.43
STHS 30	3000 Haki Standard	3.0	118.11

Material, dimensions and surface treatment can be customized on request.

Haki System Scaffold

Haki Guardrail

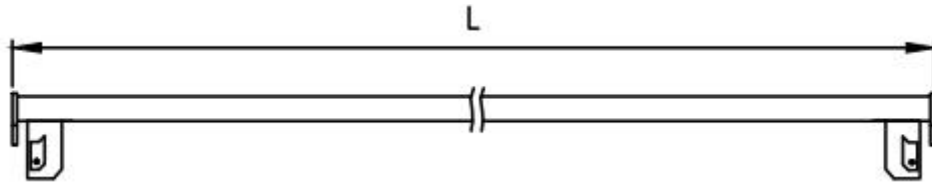

Item No.	Description	L(Meters)	L(Inches)
STHG	2160 Haki Guardrail	2.16	85.04

Haki Guard frame

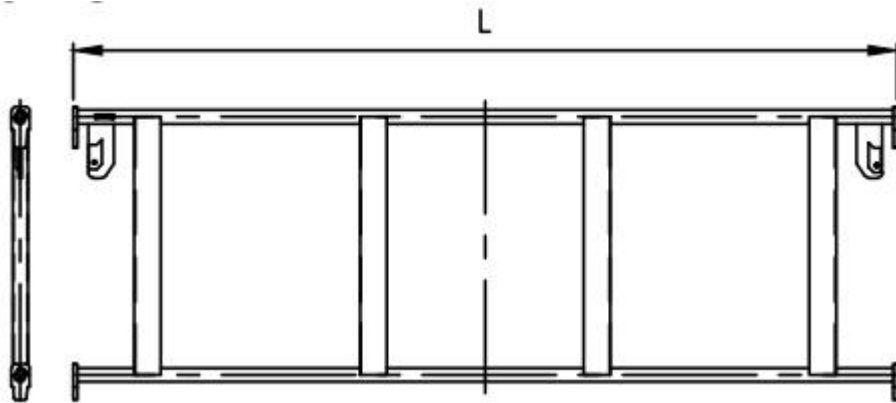

Item No.	Description	L(Meters)	L(Inches)
STHGF	1605 Haki Guard frame	1.605	63.19
STHGF	3000 Haki Guard frame	3.0	118.11

Haki Folding guardrail

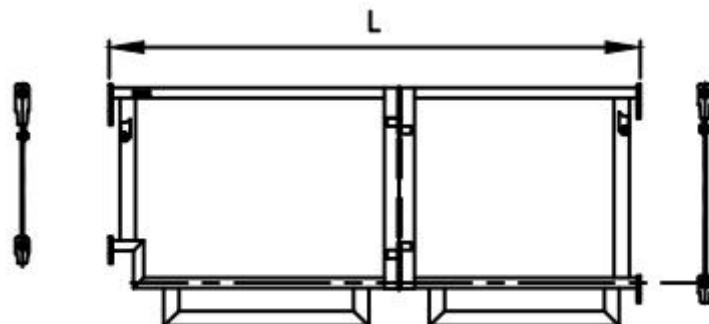

Material, dimensions and surface treatment can be customized on request.

Haki System Scaffold

Haki Handrail post

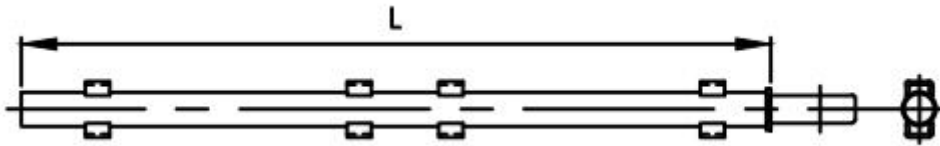

Haki Clip on post

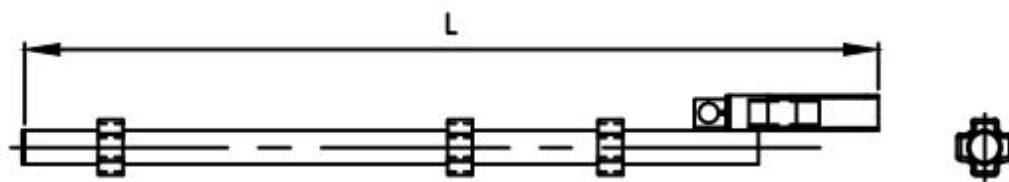

Haki Stair flight

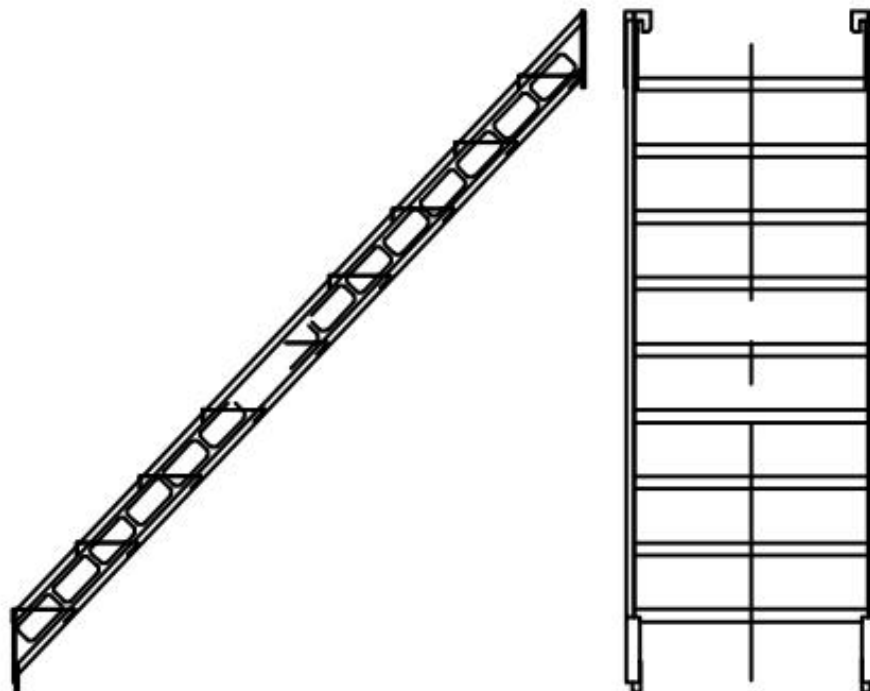

Material, dimensions and surface treatment can be customized on request.

Haki System Scaffold

Haki Stair Rail

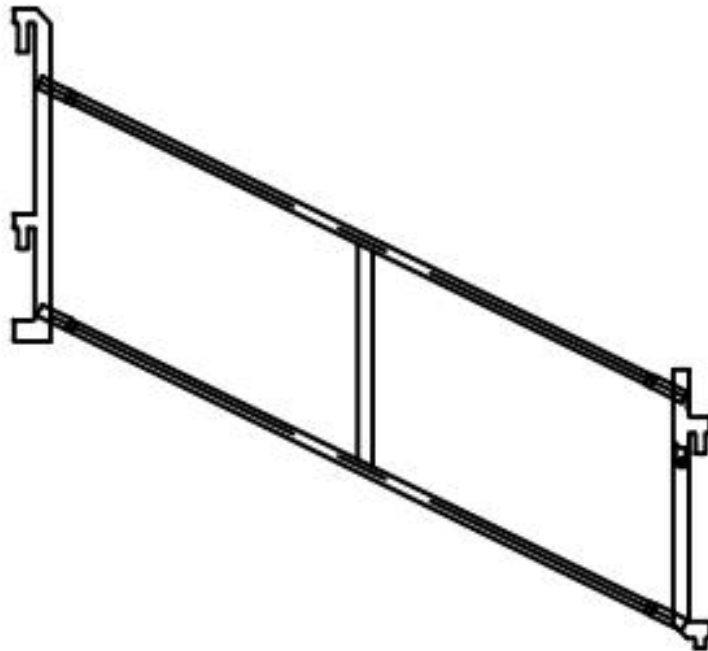

Haki Landing

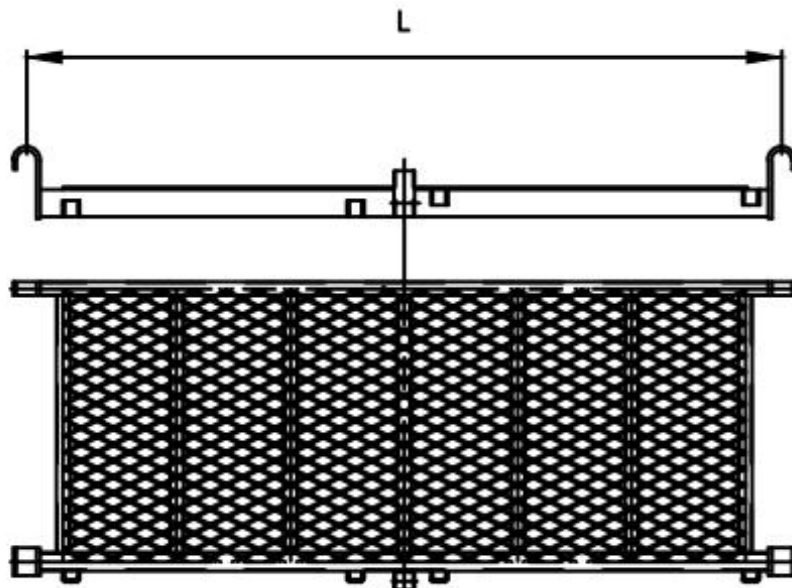

Material, dimensions and surface treatment can be customized on request.

Frame System Scaffold

Step Frame

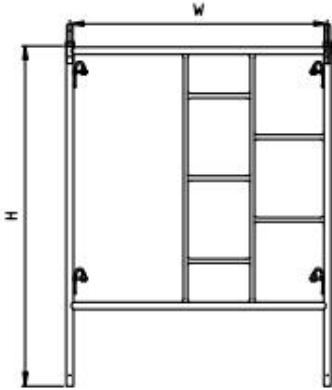

Item No.	Description	W(Meters)	H(Meters)	W(Inches)	H(Inches)
STSF 01	5'3' Step Frame	1524	0.914	60	36
STSF 02	5'4' Step Frame	1524	1.129	60	48
STSF 03	5'5' Step Frame	1524	1.524	60	60
STSF 04	5'6'4" Step Frame	1524	1.93	60	76

Step Frame

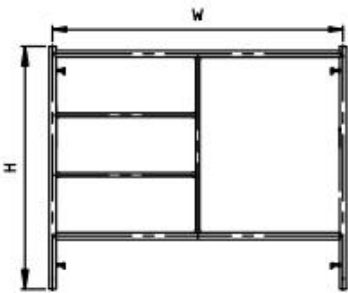

Item No.	Description	W(Meters)	H(Meters)	W(Inches)	H(Inches)
STSF 05	5'3' Step Frame	1524	0.914	60	36
STSF 06	5'4' Step Frame	1524	1.129	60	48
STSF 07	5'5' Step Frame	1524	1.524	60	60
STSF 08	5'6'4" Step Frame	1524	1.93	60	76

Walk Through Frame

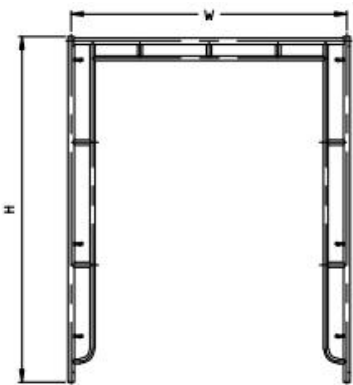

Item No.	Description	W(Meters)	H(Meters)	W(Inches)	H(Inches)
STWF 01	5'3' Walk Through Frame	1524	0.914	60	36
STWF 02	5'4' Walk Through Frame	1524	1.129	60	48
STWF 03	5'5' Walk Through Frame	1524	1.524	60	60
STWF 04	5'6'4" Walk Through Frame	1524	1.93	60	76
STWF 05	5'6'7" Walk Through Frame	1524	2.007	60	79

Material, dimensions and surface treatment can be customized on request.

Frame System Scaffold

Ladder Frame

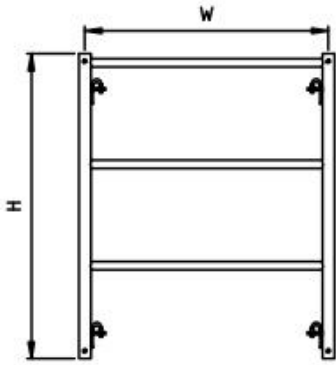

Item No.	Description	W(Meters)	H(Meters)	W(Inches)	H(Inches)
STLF 01	2'5' Ladder Frame	0.61	1.524	24	60
STLF 02	2'6'4" Ladder Frame	0.61	1.93	24	76
STLF 03	3'4' Ladder Frame	0.914	1.219	36	48
STLF 04	3'5' Ladder Frame	0.914	1.524	36	60
STLF 05	3'6" Ladder Frame	0.914	1.829	36	72

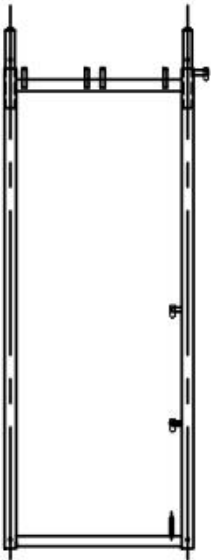

Guard Rail

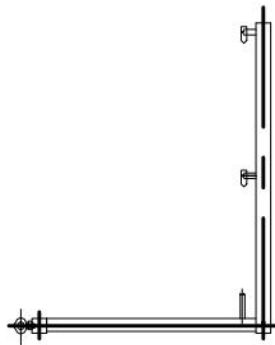

U-guard Rail

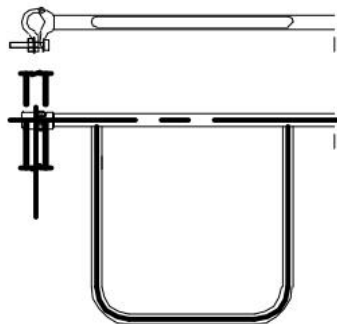

Double Front

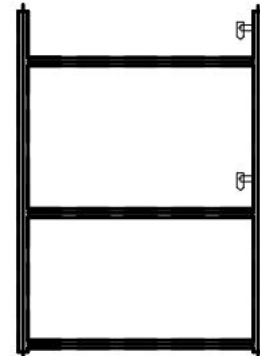

Material, dimensions and surface treatment can be customized on request.

Frame Scaffold System

Cross Brace

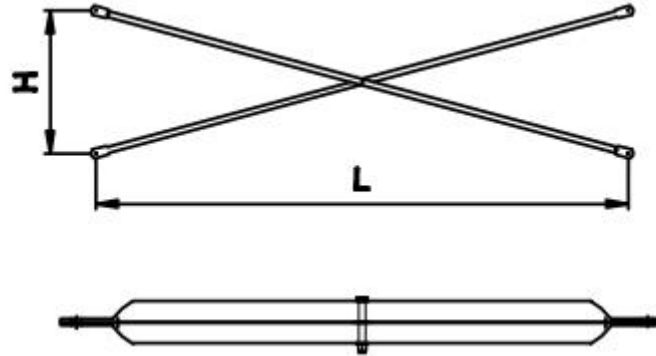

Item No.	Description	W(Meters)	H(Meters)	W(Inches)	H(Inches)
STCB 01	4'*2' Cross Brace	1.2192	0.6096	48	24
STCB 02	4'*4' Cross Brace	1.2192	1.2192	48	48
STCB 03	5'*2' Cross Brace	1.524	0.6096	60	24
STCB 04	5'*4' Cross Brace	1.524	1.2192	60	48
STCB 05	6'*2' Cross Brace	1.8288	0.6096	72	24
STCB 06	6'*4' Cross Brace	1.8288	1.2192	72	48
STCB 07	7'*2' Cross Brace	2.1336	0.6096	84	24

Guard Rail

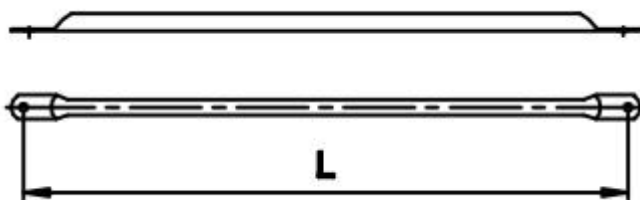

Guard Rail Post

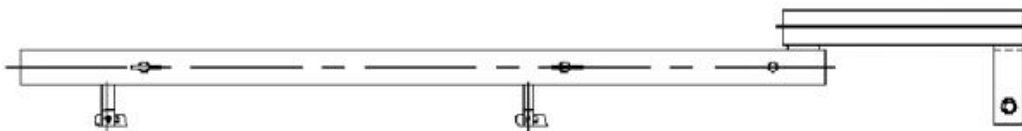

Material, dimensions and surface treatment can be customized on request.

Frame Scaffold Accessories

Frame Scaffold Locks



Drop Lock



Flip Lock



Fast Lock



C Lock



Canada Lock



Snap on Lock



V Lock

Frame Scaffold Locking Pin



Gravity Pin



Pig Tail Pin



Rivet Pin



Roll Pin



spring pin



span pin

Joint Pin



Material, dimensions and surface treatment can be customized on request.

Steel Prop

Heavy Duty Props

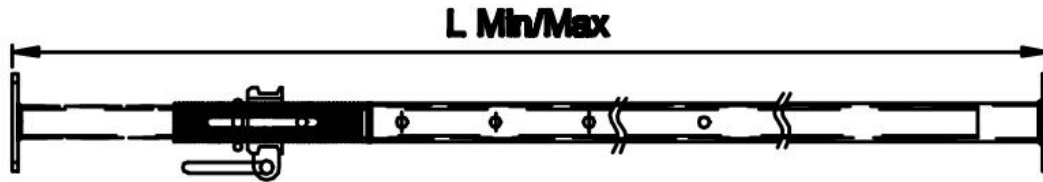

Item No.	Description	Min(Meters)	Max(Meters)	Min(Inches)	Max(Inches)
STHP01	Heavy Duty Props	1.2	2.0	47.24	78.74
STHP02	Heavy Duty Props	1.8	3.2	70.87	125.98
STHP03	Heavy Duty Props	2.2	3.9	86.61	153.54
STHP04	Heavy Duty Props	3.0	5.0	118.11	196.85

Light Duty Props

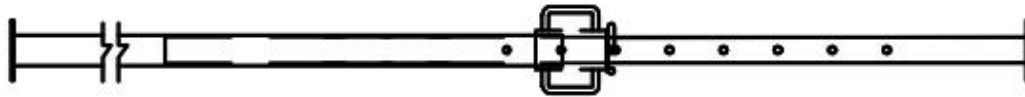

Item No.	Description	Min(Meters)	Max(Meters)	Min(Inches)	Max(Inches)
STLP01	Light Duty Props	1.2	2.0	47.24	78.74
STLP02	Light Duty Props	1.8	3.2	70.87	125.98
STLP03	Light Duty Props	2.2	3.9	86.61	153.54
STLP04	Light Duty Props	3.0	5.0	118.11	196.85

Light Tripod

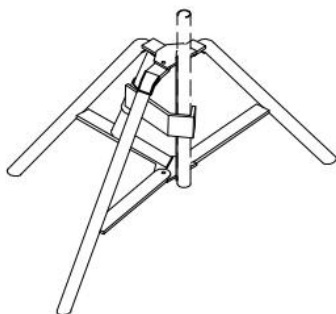

Heavy Tripod

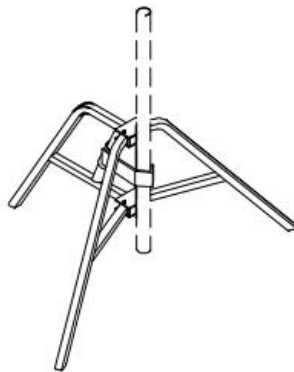

Head 1

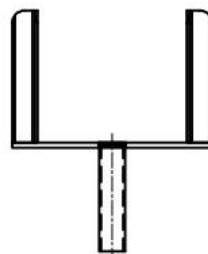

Head 2

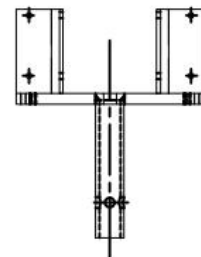

Material, dimensions and surface treatment can be customized on request.

Steel Prop Accessories



Sleeve



Pin



Plate



Cup Nut



Nut with Handle

Packing Rack

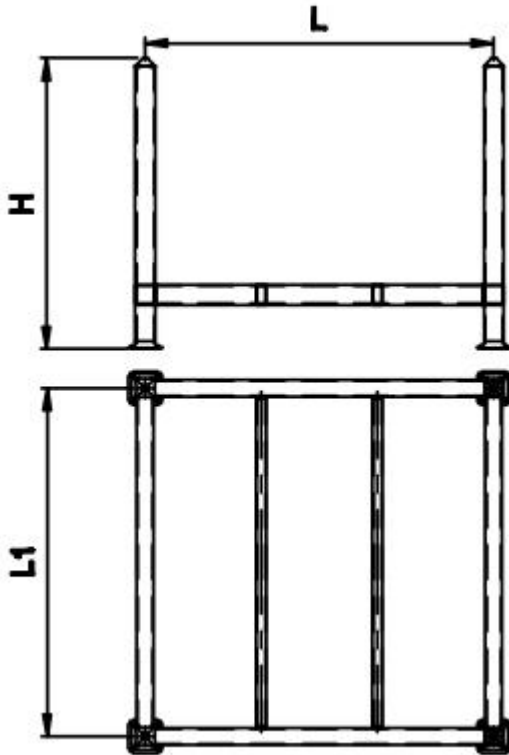

Steel Packing Rack

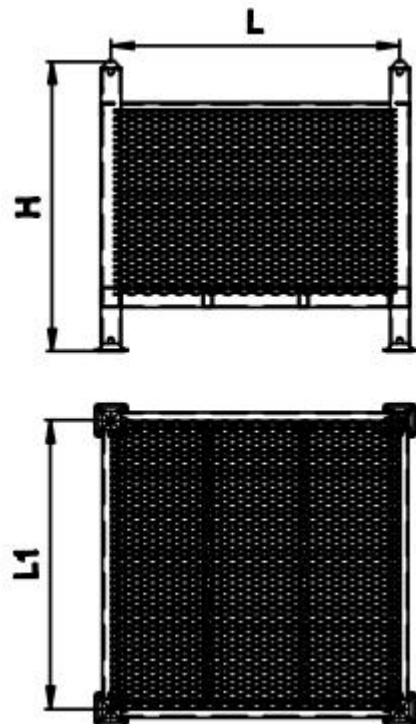

Mesh Rack

Material, dimensions and surface treatment can be customized on request.

Steel Grating

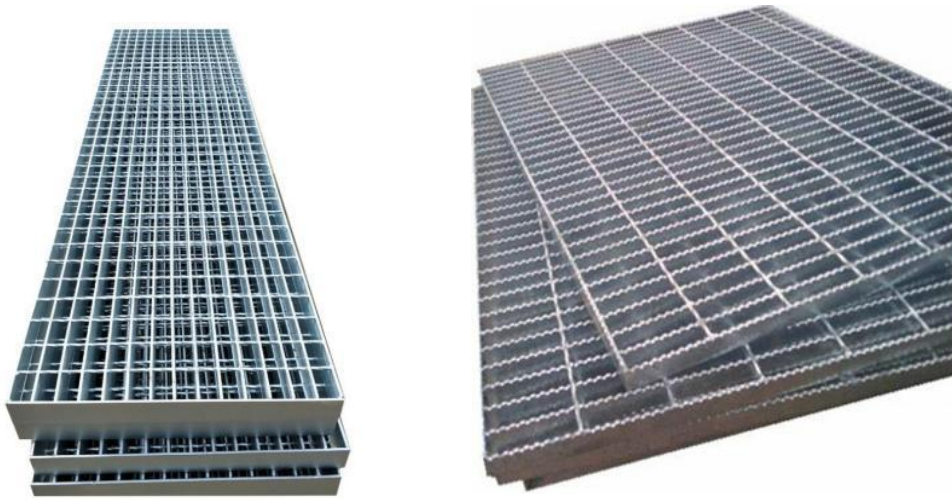

Item	Description
Bearing Bar	25x3, 25x4, 25x4.5, 25x5, 30x3, 30x4, 30x4.5, 30x5, 32x5, 40x5, 50x5, 65x5, 75x6, 75x10---100x10mm etc I bar: 25x5x3, 30x5x3, 32x5x3, 40x5x3 etc US standard: 1"x3/16", 1 1/4"x3/16", 1 1/2"x3/16", 1"x1/4", 1 1/4"x1/4", 1 1/2"x1/4", 1"x1/8", 1 1/4"x1/8", 1 1/2"x1/8" etc
Bearing Bar Pitch	12.5, 15, 20, 23.85, 25, 30, 30.16, 30.3, 32.5, 34.3, 35, 38.1, 40, 41.25, 60, 80mm etc US standard: 19-w-4, 15-w-4, 11-w-4, 19-w-2, 15-w-2 etc
Twisted Cross Bar Pitch	38.1, 50, 60, 76, 80, 100, 101.6, 120mm, 2" & 4" etc
Material Grade	ASTM A36, A1011, A569, Q235, S275JR, SS304, SS400, Mild steel & Low carbon steel, etc
Surface Treatment	Black, self colour, hot dip galvanized, painted, spray coating
Grating Style	Plain / Smooth, Serrated /teeth, I bar, serrated I bar
Standard	China: YB/T 4001.1-2007, USA: ANSI/NAAMM(MBG531-88), UK: BS4592-1987, Australia: AS1657-1985, Germany: DIN24537-1-2006, Japan :J

Aluminum Formwork



Aluminum Formwork Accessories



Wing Nut

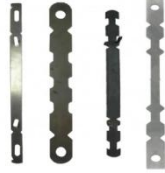

Flat Tie



U Clip



Tie Rod



Wedge Pin



Washer Plate



Panel Puller



Flat Rib Washer

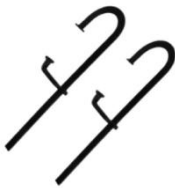

Concrete Clamp



Universal Clamp



Water Bracket



Spring Clamp



Cone Nut



Water Stopper



Large Diagonal
Brace



Turnbuckle clamp



Tie Rod

Aluminum Products

Aluminum Scaffold Tower

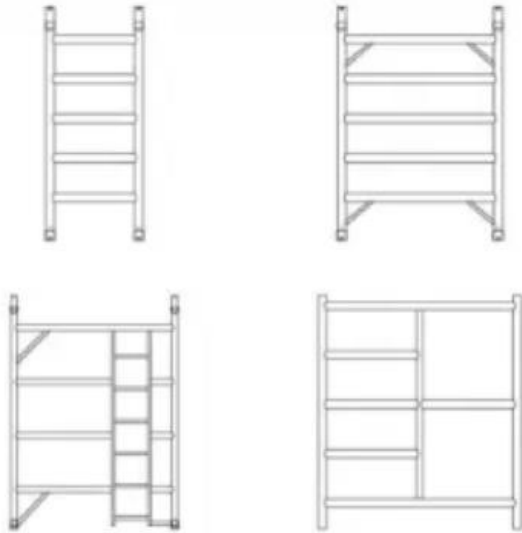

Frame



Ledger



Caster With Screw Jack



Stabilizer



Diagonal Brace



Toe Board

Aluminum Plank

Aluminum Plywood Deck



Item No.	Material	Width	Length
STAPD-3'	6061-T6	19'	3'
STAPD-4'	6061-T6	19'	4'
STAPD-5'	6061-T6	19'	5'
STAPD-6'	6061-T6	19'	6'
STAPD-6'	6061-T6	19'	7'
STAPD-7'	6061-T6	19'	8'

Aluminum Plywood Trapdoor Deck



Item No.	Description	L(Meters)	L(Inches)
STSP 610-730	W610 Steel Plank	0.73	28.74
STSP 610-1090	W610 Steel Plank	1.09	42.91
STSP 610-1570	W610 Steel Plank	1.57	61.81
STSP 610-2070	W610 Steel Plank	2.07	81.50
STSP 610-2570	W610 Steel Plank	2.57	101.18
STSP 610-3070	W610 Steel Plank	3.07	120.87

All Aluminum Plank



Item No.	Material	Width	Length
STAAP-3'	6061-T6	19.25'	3'
STAAP-4'	6061-T6	19.25'	4'
STAAP-5'	6061-T6	19.25'	5'
STAAP-6'	6061-T6	19.25'	6'
STAAP-6'	6061-T6	19.25'	7'
STAAP-7'	6061-T6	19.25'	8'

Aluminum Truss



Aluminum Spigot Truss



Aluminum Bolted Truss



Aluminum Truss Accessories

Aluminum Ladder



Aluminum Extension Ladder



Aluminum Multi-Purpose Folding Ladder



Aluminum House Hold Ladder



Aluminum Telescopic Ladder



Aluminum Dual Purpose Ladder



Aluminum Work Platform

Scaffolding Couplers



British Drop Forged Swivel Coupler



British Drop Forged Double Coupler



Limpet Coupler



Forged Putlog Coupler



Inner Joint Pin



British Pressed Swivel Coupler



Pressed Putlog Coupler



Board Retaining Clamp



Pressed Half Coupler

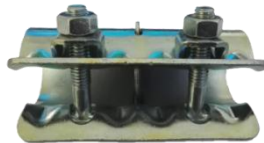

Sleeve Coupler



British Pressed Double Coupler



90° Pressed Swivel Coupler



Girder Coupler



Single Coupler



Toe Board Clamp



Ladder Clamp



Clamp Cover



Tube End Cap



110° Pressed Double Coupler



110° Pressed Swivel Coupler

Quality Control

Every manufacturing process of our products is strictly controlled. We have a perfect quality controlling system and scientific quality controlling methods to guarantee product quality.

Raw Material Inspection



Tube Diameter Inspection



Thickness Inspection

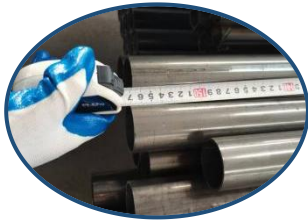

Tube Length Inspection

Manufacturing Process Inspection



Weld Depth Inspection



Dimension Inspection



Welding Inspection

Finished Product Inspection

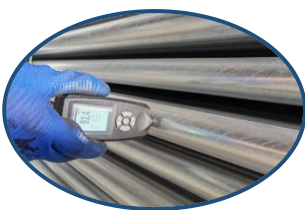

Galvanized Inspection



Cross-cut Test

Packing & Delivery



SUTAI

Formwork & Scaffolding

Henan Sutai Construction Equipment Co., Ltd

Tel: +86 13460662701

Email: sutai@sutai-scaffold.com

Website: www.sutai-scaffold.com

Address: No.403, Unit 1, Building 1, Manhattan Commercial Plaza, Jinshui District, Zhengzhou City, Henan Province, China.